

01053675

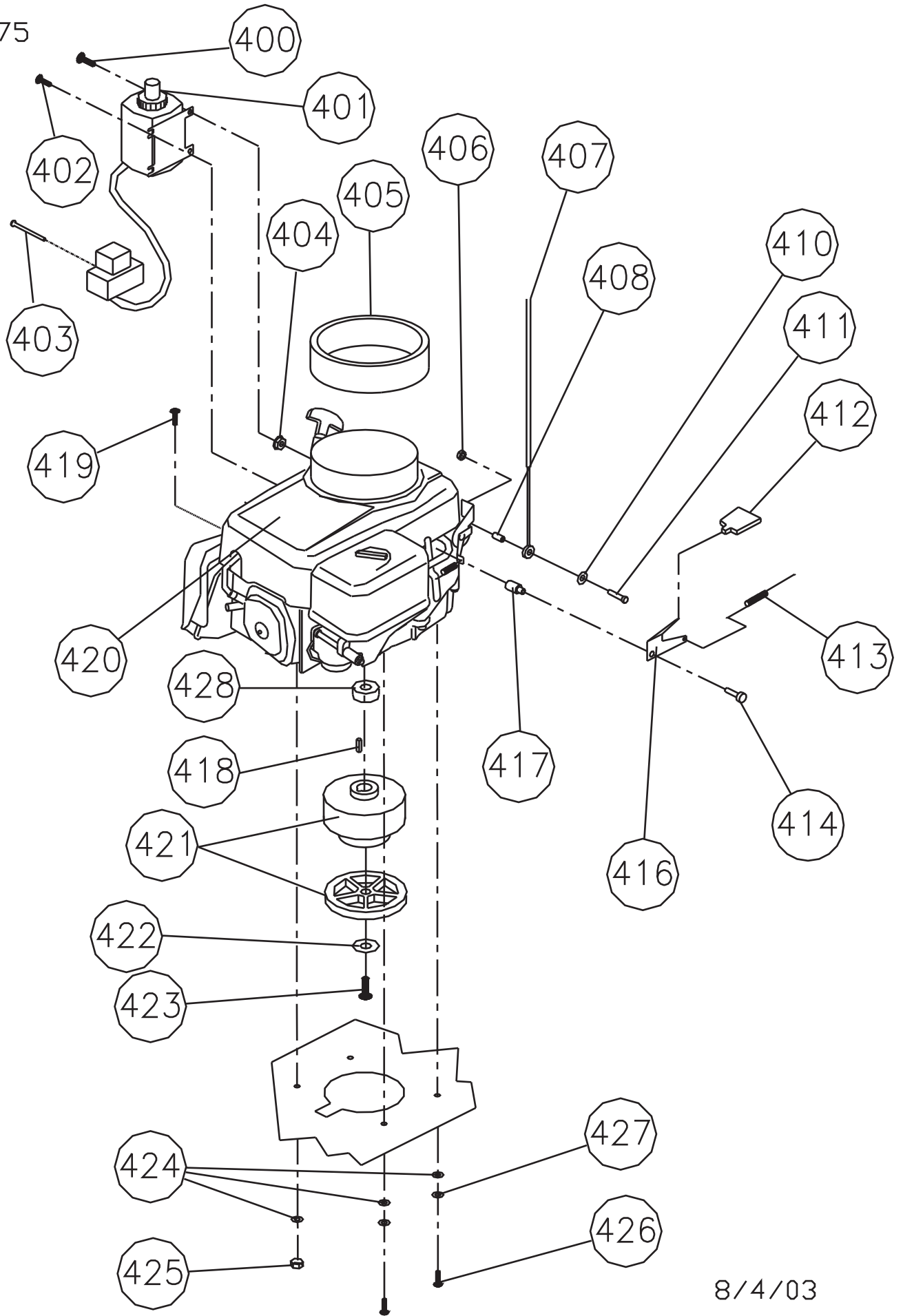

8/4/03